

## VTOF002+VTOB113

### Front Panel for 2 Modules

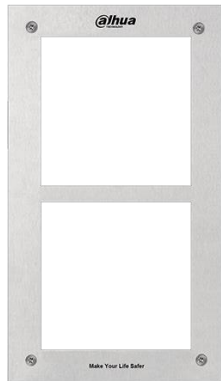

### Features

- Material: Stainless Steel
- Size: 257mm\*145 mm\*11 mm
- Weight: 0.5kg
- Front Panel

### Dimensions

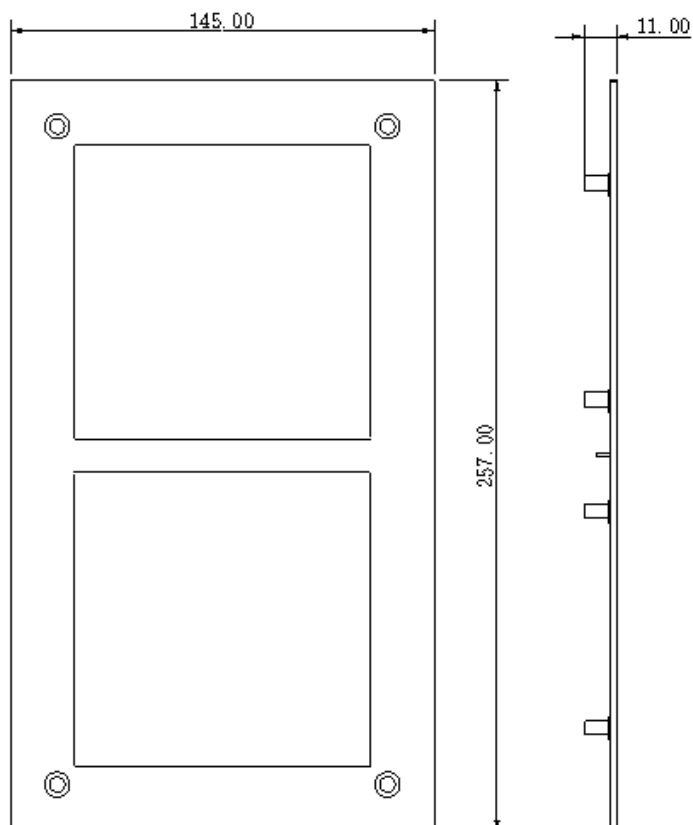

VTOF002+VTOB113

## Surface Mounted Box for 2 Modules





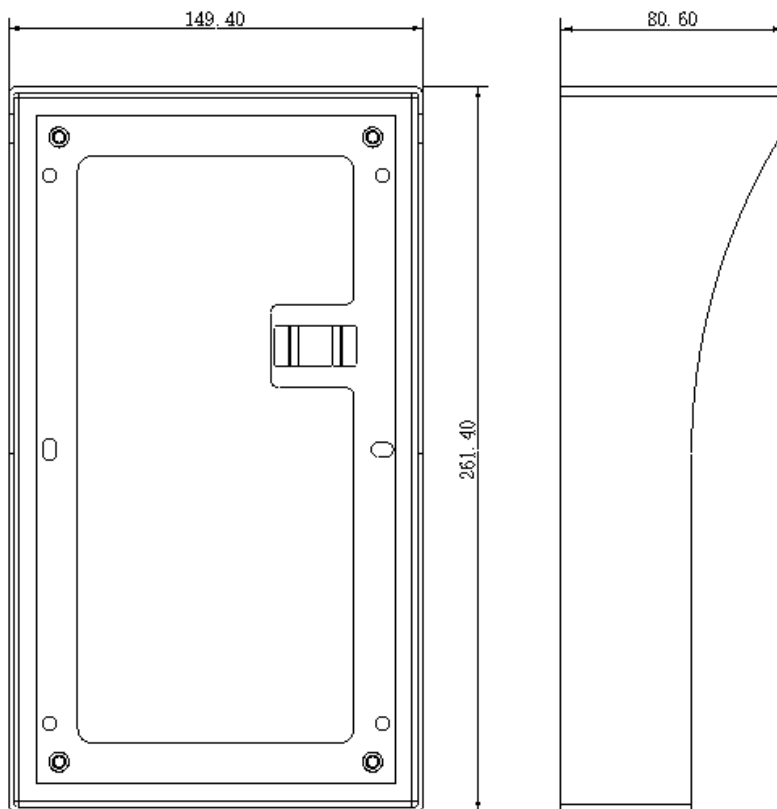

### Features

- Material: Aluminum
- Size: 261.4 mm\*149.4 mm\*80.6 mm
- Weight: 0.8kg
- Surface Mounted Box

### Dimensions



## Installation

Component Name	Illustration	Quantity
M4×40 inner hex flower sunk head flat tail machine screw		4
M3×6 cross recessed countersunk flat tail machine screw		4 in each module
ST3×18 cross recessed countersunk head tail tapping screws		6
White expansion tube $\varnothing$ 6×30mm		6

- Step 1. Install case on wall. Fix with screw (ST3×18 cross recessed countersunk head tail tapping screws), and the case is fastened
- Step 2. Align the device on front panel with hole position. Fix with screw (M3×6 cross recessed countersunk flat tail machine screw), and the module is fastened on front panel.
- Step 3. Fix front panel on case according to hole position, fix with (M4×40 inner hex flower sunk head flat tail machine screw), and front panel is fastened on the case.
- Step 4. Write room no. on provided name card or name of resident. Insert name card cover.

### Note:

- Name card and name card cover are included in accessories by default.
- Module VTO has two packages of 2 modules and 3 modules. The figure takes 3 modules as an example.
- You may power up device only after all modules are well connected, otherwise module connected after power up will not operate.

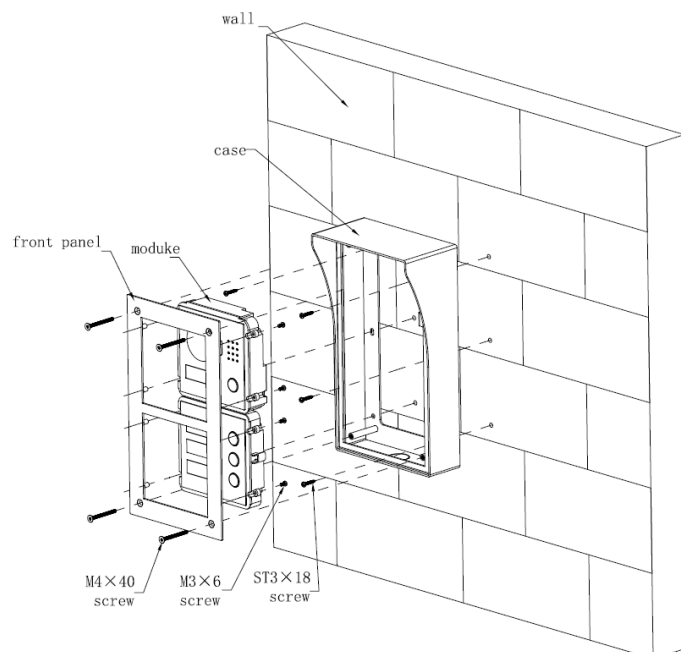

VTOF002+VTOB113

---

