

DH-PFA101

Mount Adapter



Features

- Aesthetic design
- Material: aluminum
- Mount adapter

Technical Specifications

Model	DH-PFA101
General	
Material	Aluminum
Dimension	Φ159mmx35mm (Φ6.26"x1.38")
Pipe Thread	G1 1/2"
Load Bearing	3.0kg(6.61lb)
Weight	0.24kg(0.53lb)
Color	White
Operating Temperature	-40°C ~ +60°C (-40°F ~ +140°F)
Humidity	<90% RH
Applicable Model	Please see "Accessory Selection"

Order Information

Type	Part Number	Description
Camera Mount	DH-PFA101	Mount adapter
	PFA101	Mount adapter

Dimensions (mm/inch)

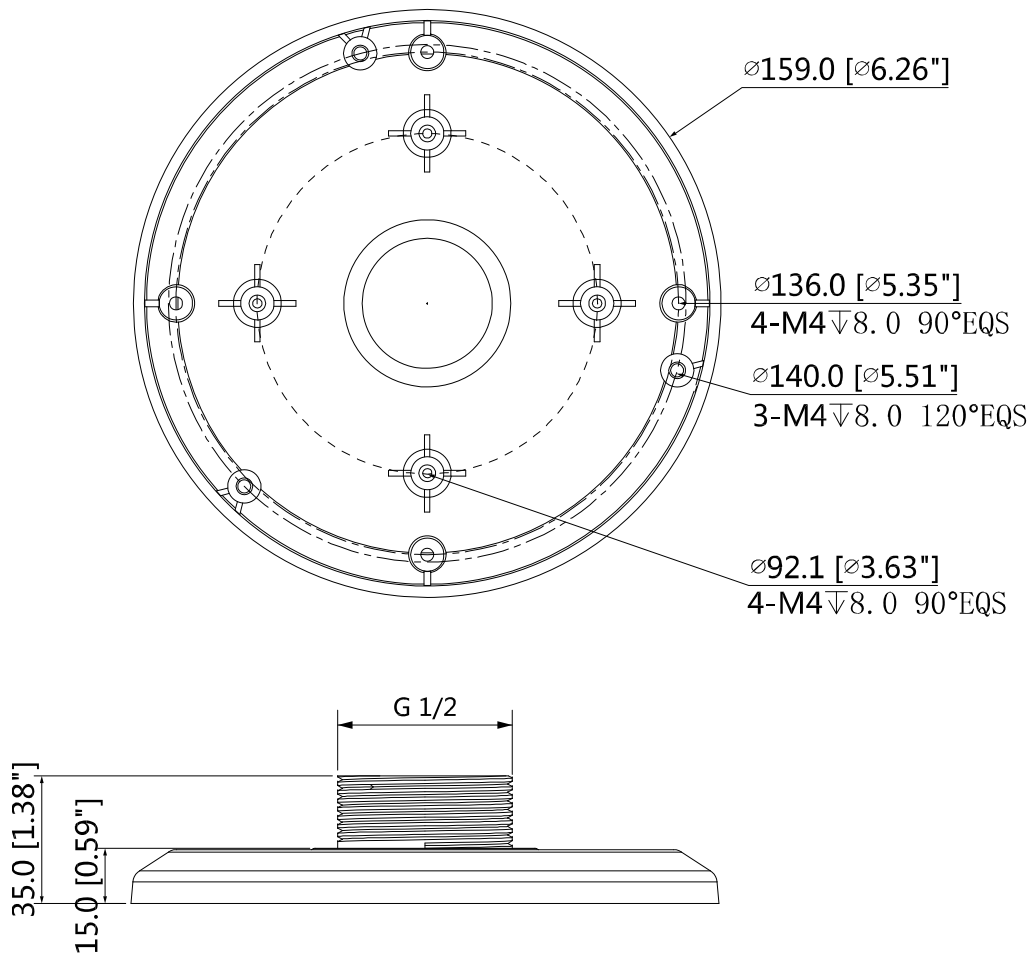

Application

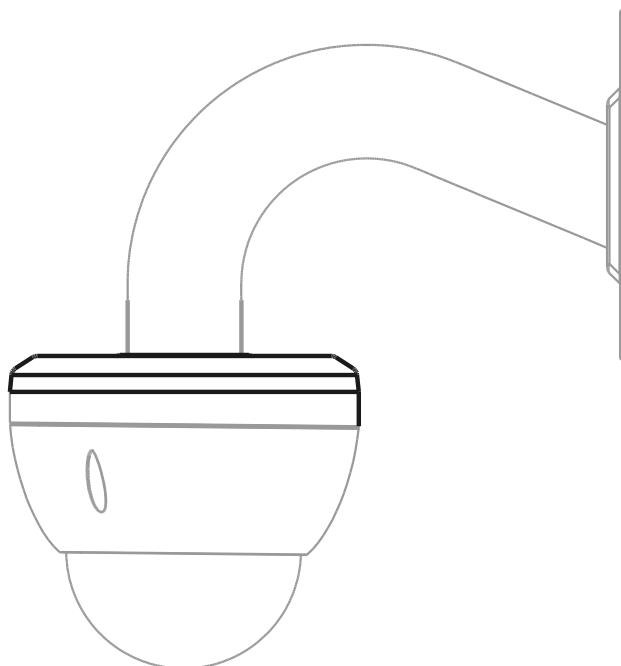

Package Information

- Mount adapter *1