

# DH-PFA124-B

## Water-proof Junction Box



### Features

- Neat & Integrated design
- Material: Aluminum
- IP66

### Technical Specifications

<b>Model</b>	<b>DH-PFA124-B</b>
<b>General</b>	
Material	Aluminum
Dimension (W x H x D)	134.0mmx133.5mmx56.0mm (5.28"x5.25"x2.2")
Pipe thread	G3/4"
Weight	0.54kg(1.19lb)
Load Bearing	3.0kg(6.61lb)
Color	Black
Protection	IP66
Operating Temperature	-40°C ~60°C(-40°F ~140°F)
Humidity	0~90% RH
Applicable Model	HAC-PFW3601-A180

### Order Information

Type	Part Number	Description
Camera mount	DH-PFA124-B	Water-proof junction box
	PFA124-B	Water-proof junction box

### Dimensions (mm/inch)

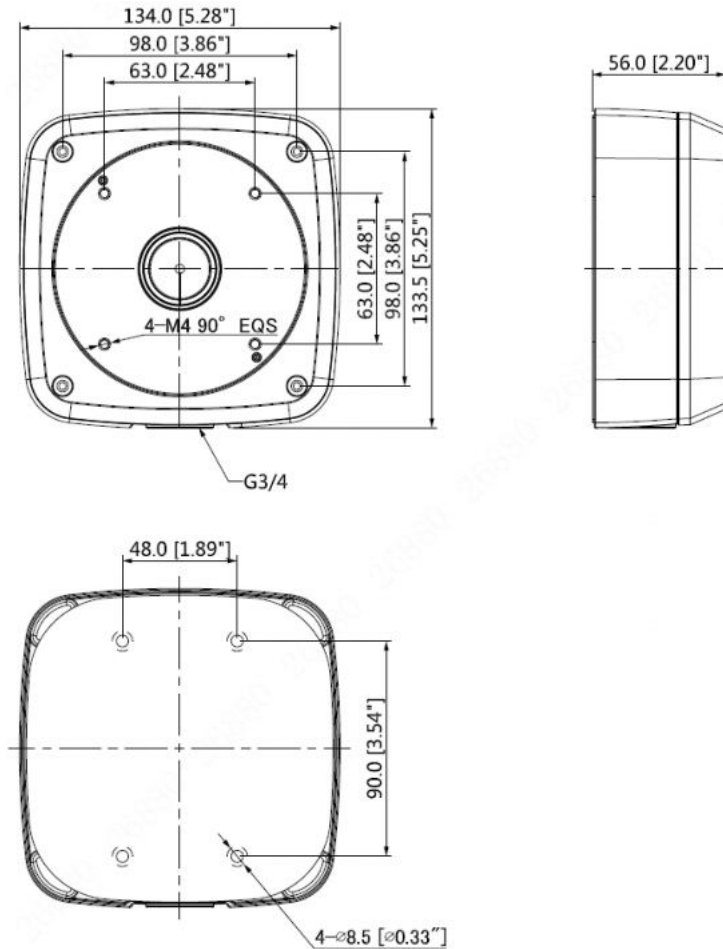

## Application

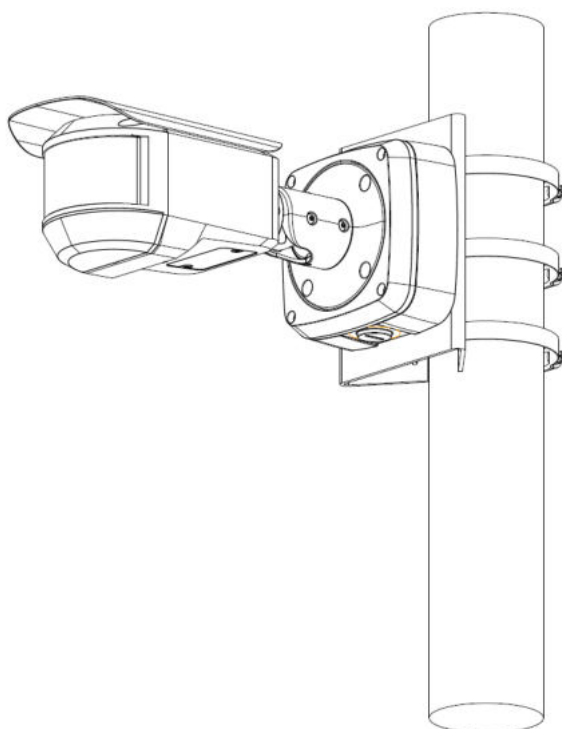

## Package Information

- Water-proof junction box \*1
- M4x10 screw \*4
- ST4.2x25 screw \*4
- Plastic Anchor: 4
- S3.0 wrench \*1