

PTZ-I4EN30-ASL | 4MP 30x IR PTZ Network Camera

- 1/3" 4Megapixel CMOS
- Powerful 30x optical zoom
- H.265 Encoding
- Max. 25/30fps@4M/3M, 25/30/50/60fps@1080P
- Auto-tracking and IVS
- IR distance up to 100m
- IP66

System Overview

With powerful optical zoom and accurate pan/tilt/zoom performance, this PTZ camera can provide a large monitoring range and great detail. The camera delivers 1080P resolution at 50/60 fps, with 30x optical zoom. The PTZ-I4EN30-ASL is equipped with quick and smooth control, high quality image and good protection, which make it can meet most of the requirements of video surveillance applications.

Functions
Wide Dynamic Range

Embedded with industry leading wide dynamic range (WDR) technology, vivid pictures are achieved even in the most intense contrast lighting conditions. For applications with both bright and low lighting conditions that change quickly, true WDR (120dB) optimizes both the bright and dark areas of a scene at the same time to provide usable video.

Auto-tracking

The camera supports auto-tracking. The tracking action can be triggered manually or automatically by defined rules. Once rules are triggered, the camera can zoom in and track the defined target automatically.

High Efficiency Video Coding (H.265)

The H.265 (ITU-T VCEG) video compression standard offers double the data compression ratio at the same level of video quality, or substantially improved video quality at the same bit rate, as compared to older video compression technologies. H.265 offers such impressive compression by expanding the pattern comparison and difference coding, improving motion vector prediction and motion region merging, and incorporating an additional filtering step called sample-adaptive offset filtering.

Environmental

With a temperature range of -40 °C to +60 °C (-40 °F to +140°F), the camera is designed for extreme temperature environments. Subjected and certified to rigorous dust and water immersion tests, the IP66 rating makes it suitable for demanding outdoor applications.

Protection

This camera suits even the harsh conditions for outdoor applications. Its 6KV lightning rating provides protection against the camera and its structure from the effects of lightning.

Interoperability

The camera conforms to the ONVIF (Open Network Video Interface Forum) and PSIA (Physical Security Interoperability Alliance) specifications, ensuring interoperability between network video products regardless of manufacturer.

Interoperability

The camera conforms to the ONVIF (Open Network Video Interface Forum) and PSIA (Physical Security Interoperability Alliance) specifications, ensuring interoperability between network video products regardless of manufacturer.

PTZ-I4EN30-ASL | 4MP 30x IR PTZ Network Camera
Technical Specifications



Camera				
Image Sensor	1/3" CMOS			
Effective Pixels	2592(H) x 1520(V), 4 Megapixels			
RAM/ROM	1024M/128M			
Scanning System	Progressive			
Electronic Shutter Speed	1/1s~1/300,000s			
Minimum Illumination	Color: 0.05Lux@F1.6; 0Lux@F1.6 (IR on)			
S/N Ratio	More than 55dB			
IR Distance	Distance up to 100m (328ft)			
IR On/Off Control	Auto/ Manual			
IR LEDs	6			
Lens				
Focal Length	4.5mm~135mm			
Max. Aperture	F1.6 ~ F4.4			
Angle of View	H: 60° ~ 2.2°			
Optical Zoom	30x			
Focus Control	Auto/Manual			
Close Focus Distance	100mm~ 1000mm			
DORI Distance	Detect	Observe	Recognize	Identify
	2700m	1080m	540m	270m
Pan/Tilt/Rotation				
Pan/Tilt/Rotation	Pan: 0° ~ 360° endless Tilt: -15° ~ 90° auto flip 180°			
Manual Control Speed	Pan: 0.1° ~ 160° /s Tilt: 0.1° ~ 120° /s			
Preset Speed	Pan: 240° /s; Tilt: 200° /s			
Presets	300			
PTZ Mode	5 Pattern, 8 Tour, Auto Pan ,Auto Scan			
Speed Setup	Human-oriented focal Length/ speed adaptation			
Power up Action	Auto restore to previous PTZ and lens status after power failure			
Idle Motion	Activate Preset/ Scan/ Tour/ Pattern if there is no command in the specified period			
Protocol	DH-S/D, Pelco-P/D (Auto recognition)			
Intelligence				
Auto Tracking	Support			
IVS	Tripwire, Intrusion, Abandoned/Missing, Face Detection			

Video	
Compression	H.265/H.264 / MJPEG
Streaming Capability	3 Streams
Resolution	4M(2592×1520)/3M(2304×1296)/1080P(1920× 1080)/720P(1280×720)/D1(704×576/704×480)/CIF(352×288/352×240)
Frame Rate	Main Stream: 4M/3M/1.3M/720P(1~25/30fps), 1080P(1~50/60fps) Sub Stream1: D1/CIF(1 ~ 25/30fps) Sub Stream2: 1080P /1.3M/720P(1 ~ 25/30fps)
Bit Rate Control	CBR/VBR
Bit Rate	H.265/H.264: 448K ~ 8192Kbps, MJPEG: 5120K ~ 10240Kbps
Day/Night	Auto (ICR) / Color / B/W
Backlight Compensation	BLC / HLC / WDR (120dB)
White Balance	Auto, ATW, Indoor, Outdoor, Manual
Gain Control	Auto / Manual
Noise Reduction	Ultra DNR (2D/3D)
Motion Detection	Support
Region of Interest	Support
Electronic Image Stabilization (EIS)	Support
Defog	Support
Digital Zoom	16x
Flip	180°
Privacy Masking	Up to 24 areas
Audio	
Compression	G.711a/G.711Mu/AAC/G.722 / G.726/G.729/ MPEG2-L2
Network	
Ethernet	RJ-45 (10/100Base-T)
Protocol	IPv4/IPv6, HTTP, HTTPS, SSL, TCP/IP, UDP, UPnP, ICMP, IGMP, SNMP, RTSP, RTP, SMTP, NTP, DHCP, DNS, PPPoE, DDNS, FTP, IP Filter, QoS, Bonjour, 802.1x
Interoperability	ONVIF, PSIA, CGI
Streaming Method	Unicast / Multicast
Max. User Access	20 users

PTZ-I4EN30-ASL | 4MP 30x IR PTZ Network Camera
Technical Specifications

Edge Storage	NAS (Network Attached Storage), Local PC for instant recording, Micro SD card 128GB
Web Viewer	IE, Chrome, Firefox, Safari
Management Software	Smart PSS, DSS
Smart Phone	IOS, Android
Certifications	
Certifications	CE: EN55032/EN55024/EN50130-4 FCC: Part15 subpartB,ANSI C63.4- 2014 UL: UL60950-1+CAN/CSA C22.2,- No.60950-1
Interface	
Video Interface	1
Audio Interface	1/1
RS485	1
Alarm	2/1
Electrical	
Power Supply	AC24V/3A (±10%)
Power Consumption	10.5W,26W (IR on)
Environmental	
Operating Conditions	-40°C ~ 60°C (-40°F ~ +140°F) / Less than 90% RH
Ingress Protection	IP66
Vandal Resistance	N/A
Construction	
Casing	Metal
Dimensions	Φ204.7(mm) x 359.9(mm)
Net Weight	7.8kg (17.20lb)
Gross Weight	8.3kg (18.30lb)

Accessories (included)



Wall Mount: OS-64FB	Power Supply: AC24V/3A
	

Accessories (optional)

Mount adapter: OS-PFA114	Wall Mount: OS-PFB303W	Power Box: OS-PFA140
		
Ceiling Mount: OS-PFB300C	Junction Box: OS-PFA120	Pole Mount: OS-PFA150
		
Corner Mount: OS-PFA151	Parapet Mount: OS-PFB303S	
		

PTZ-I4EN30-ASL | 4MP 30x IR PTZ Network Camera

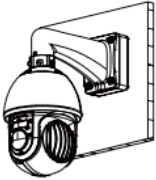
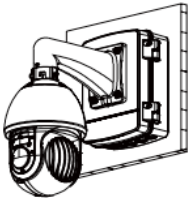
Accessories

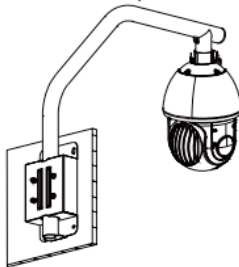
<p>Ceiling Mount: OS-PFA114 + OS-PFB300C</p>	<p>Junction Mount: OS-PFA114 + OS-PFB303W + OS-PFA120</p>
	
<p>Power Box Mount: OS-PFA114 + OS-PFB303W + OS-PFA140</p>	<p>Pole Mount: OS-PFA114 + OS-PFB303W + OS-PFA150</p>
	
<p>Corner Mount: OS-PFA114 + OS-PFB303W + OS-PFA151</p>	<p>Parapet Mount: OS-PFA114 + OS-PFB303S</p>
	

Dimensions (mm)

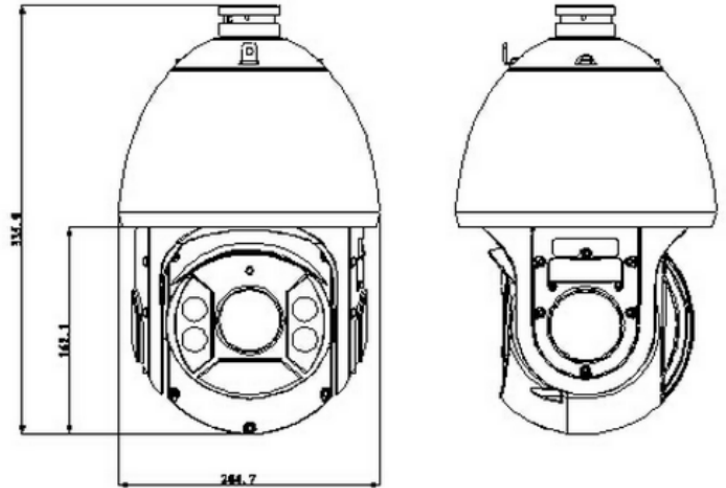

* The information contained in this document (photos, drawings, dimensions, specifications) may be subject to change without prior notice.
 ** Copyright© Osiris Security. All rights reserved. The information in this document can not be published, rewritten or republished in any form. If you wish to use the text or images in this document for commercial reasons, please contact marketing@osiris-security.com