

DH-PFB2204W-B

Wall Mount Bracket



- Built of aluminum alloy and SGCC material.
- Suitable for a variety of cameras and is elegant.



Series Overview

The Mounting Bracket works with front-end services, supporting installation methods such as wall mount, pole mount, corner mount and in-ceiling mount. Select brackets are designed to suit complex scenes, making them convenient to use in environments with high temperatures, humidity, frequent vibrations, and in locations that are highly corrosive. These highly reliable brackets are easy to install and use.

Scene

Ideal for mounting cameras, and works in temperatures ranging from -40°C to $+60^{\circ}\text{C}$ (-40°F to $+140^{\circ}\text{F}$) and in environments with a relative humidity of less than 90%.

Technical Specification

Structure

Casing Material	SGCC; Aluminum alloy
Product Dimensions	162.0 mm × 129.4 mm × 80.0 mm (6.38" × 5.09" × 3.15") (L × W × H)
Appearance Color	Black
Net Weight	0.49 kg (1.08 lb)
Gross Weight	0.57 kg (1.26 lb)
Load Bearing	1.0 kg (2.20 lb)
Installation	Wall mount
Applicable Model	Please see "Camera Accessories Selection"
Packaging Dimensions	172.0 mm × 137.0 mm × 86.0 mm (6.77" × 5.39" × 3.39") (L × W × H)

Environment

Operating Temperature	-40°C to $+60^{\circ}\text{C}$ (-40°F to $+140^{\circ}\text{F}$)
Operating Humidity	< 90% (RH)
Storage Temperature	-40°C to $+60^{\circ}\text{C}$ (-40°F to $+140^{\circ}\text{F}$)
Storage Humidity	10%–90% (RH)
Anti-corrosion Level	Basic Protection

Ordering Information

Type	Model	Description
Camera Mount Series	DH-PFB2204W-B	Wall Mount Bracket

Installation

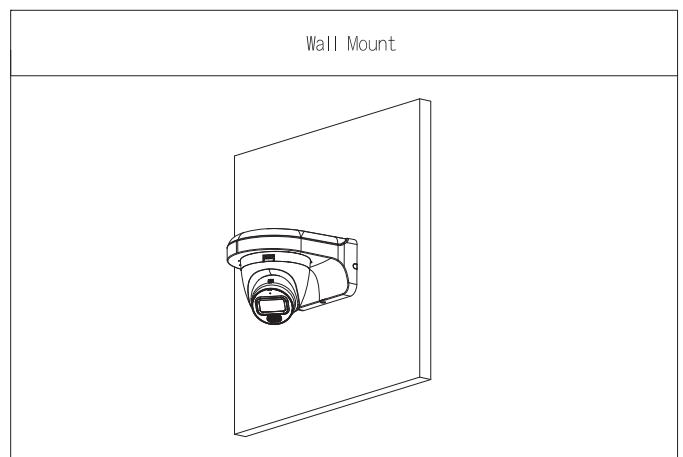

Dimensions (mm[inch])

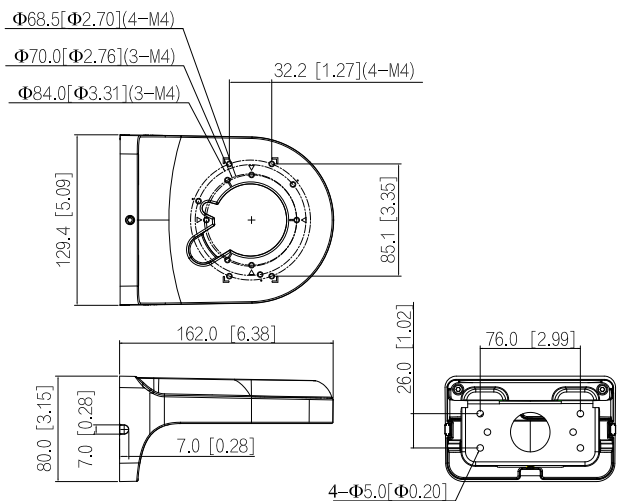

Package Information

- Wall mount bracket × 1
- M4×10 screw × 4
- ST4×25 screw × 4
- Plastic anchor × 4
- S3.0 wrench × 1